

# UNIVERSAL SYSTEM SCAFFOLD



**U** UNIVERSAL  
MANUFACTURING



# System Scaffold

UNIVERSAL MANUFACTURING

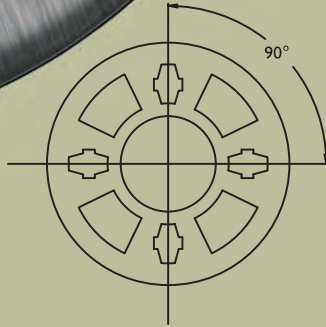

The Universal System Scaffold Rosette provides total flexibility to lock in any angle plus quickly and accurately align at 90° angles using the keyhole positions. Each Rosette can have up to eight connections at one time.

### System Scaffolding Advantages:

- Hot-dipped galvanized
- No bolts or screws
- Pre-measured components/ No measurements needed
- Erects efficiently
- Conforms to any angle or curve
- Rigid, versatile and very safe
- Can be used in conjunction with Tube and Clamp

### Standard



Part No.	Height	Weight
US17T (Topping Off Column)	1' 7"	6.0 lbs
US17 (1 Rosette)	1' 7"	6.0 lbs
US33 (2 Rosettes)	3' 3"	11.9 lbs
US411 (3 Rosettes)	4' 11"	18.0 lbs
US66 (4 Rosettes)	6' 6"	21.0 lbs
US99 (5 Rosettes)	9' 9"	30.2 lbs

### Horizontal



Part No.	Load Bearing Length	Weight
UH20 (Blank)	2'	6.0 lbs
UH30 (Yellow)	3'	8.3 lbs
UH40 (Black)	3' 6"	9.4 lbs
UH50 (Orange)	4'	10.5 lbs
UH60 (Brown)	5'	12.8 lbs

Part No.	Non-Load Bearing Length	Weight
UH60 (Blue)	6'	15.0 lbs
UH70 (Blank)	7'	17.3 lbs
UH80 (Green)	8'	19.5 lbs
UH100 (Red)	10'	24.0 lbs

### Horizontal Truss



Part No.	Load Bearing Length	Weight
UHT50 (Brown)	5'	15.6 lbs
UHT60 (Blue)	6'	18.5 lbs
UHT70 (Blank)	7'	24.5 lbs
UHT80 (Green)	8'	36.8 lbs
UHT100 (Red)	10'	39.6 lbs

### Truss

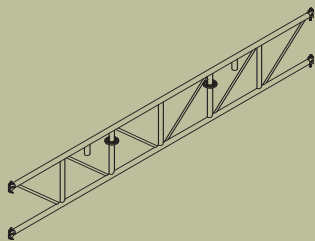

Part No.	Length	Weight
UT12	12'	81.0 lbs
UT14	14'	106.0 lbs
UT16	16'	106.0 lbs
UT20	20'	135.0 lbs

### Ladders

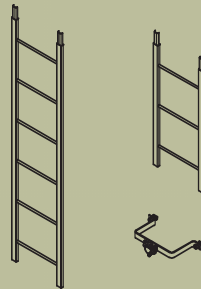

Part No.	Length	Weight
U-SAUB	Ladder Bracket	5.5 lbs
U-SAU3	3' Ladder Section	9.0 lbs
U-SAU6	6' Ladder Section	17.0 lbs

### Stairs

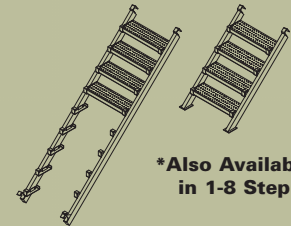

\*Also Available in 1-8 Step

Part No.	Description	Weight
USSL70	7' Left Stair Stringer	49.0 lbs
USSR70	7' Right Stair Stringer	49.0 lbs
USTL	Left Starter Stair Stringer	26.0 lbs
USTR	Right Starter Stair Stringer	26.0 lbs

Part No.	Description	Weight
UST26	2' 6" Tread (Use in 3' 6" Bay)	11.5 lbs
UST30	3' Tread (Use in 4' Bay)	13.8 lbs
UST40	4' Tread (Use in 5' Bay)	18.0 lbs

### Truss Plank Support

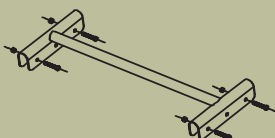

Part No.	Length	Weight
UTPS20	2'	15.1 lbs
UTPS30	3'	17.6 lbs
UTPS36	3' 6"	19.0 lbs
UTPS40	4'	19.9 lbs
UTPS50	5'	22.3 lbs

### Truss Adapters

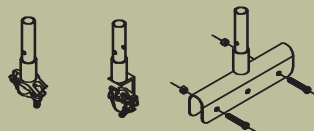

Part No.	Description	Weight
UHTCS	Clamp on Column Support	3.0 lbs
USTA	Truss Adapter	3.5 lbs
UHTCS	Truss Column Saddle	7.0 lbs

### Casters & Caster Adapters

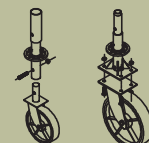

Part No.	Description	Weight
UCBC	Caster Base Collar	7.0 lbs
F-8R	8" Pin Type Caster	13.0 lbs
US12CA	12" Caster Adapter	8.5 lbs
P-12R	12" Plate Type Caster	38.0 lbs

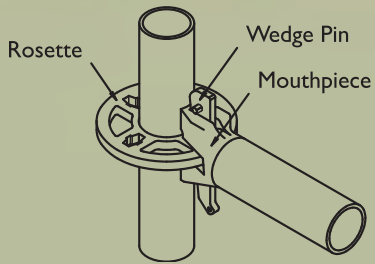

The high-strength Mouthpiece uses a Wedge Pin with a reverse slope. The Wedge Pin engages the Rosette entirely through its vertical surface, ensuring a properly seated Mouthpiece on the Rosette while the Wedge is in place. The lobes are reversed to dramatically increase the compression area of the Mouthpiece connector. This provides greater mass area at the bottom of the Mouthpiece.

### Diagonal

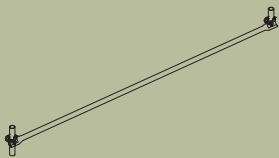

Part No.	Bay Size	Weight
UD20 (Blank)	2'	16.9 lbs
UD30 (Yellow)	3'	16.9 lbs
UD36 (Black)	3' 6"	17.3 lbs
UD40 (Orange)	4'	17.6 lbs
UD50 (Brown)	5'	18.6 lbs
UD60 (Blue)	6'	19.7 lbs
UD70 (Blank)	7'	21.5 lbs
UD80 (Green)	8'	22.2 lbs
UD100 (Red)	10'	25.0 lbs

### Side Brackets

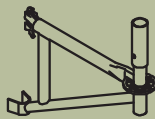

Part No.	Length	Weight
USB20	2'	14.0 lbs
USB30	3'	21.0 lbs
USB36	3' 6"	31.0 lbs

### Board Brackets

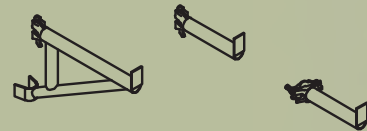

Part No.	Length	Weight
UBB010	10"	3.1 lbs
UBB010CO	10"	3.1 lbs
UBB18	1' 8"	8.0 lbs
UBB27	2' 7"	12.5 lbs

### Low Profile Steel Plank

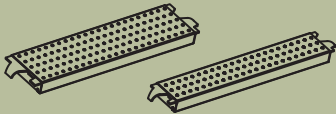

Part No.	Length	Weight
USP20ADG	2'	10.9 lbs
USP30ADG	3'	15.0 lbs
USP36ADG	3' 6"	17.0 lbs
USP40ADG	4'	19.3 lbs
USP50ADG	5'	23.0 lbs
USP60ADG	6'	27.0 lbs
USP70ADG	7'	32.0 lbs
USP80ADG	8'	35.0 lbs
USP100ADG	10'	44.0 lbs

\*All Sizes Available in 6" Wide Plank

### Scaffold Rack

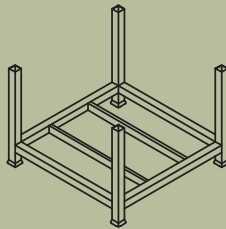

Part No.	Description	Weight
U-SR-CS	Scaffold Rack	116.0 lbs

### Hoist



Part No.	Description	Weight
USH-T	System Hoist Top	10.0 lbs
USH-B	System Hoist Bottom	15.0 lbs
HAW-12	Hoist Arm Wheel	16.5 lbs

### Adjustable Base

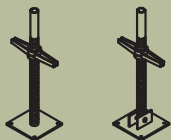

Part No.	Description	Weight
USJ20	Screw Jack	13.8 lbs
USSJ20	Swivel Screw Jack	15.0 lbs

### Plan Braces



Part No.	Bay Size	Weight
UPB3670	3' 6" x 7'	19 lbs
UPB4070	4' x 7'	19.8 lbs
UPB5070	5' x 7'	20.5 lbs

\*Call for additional sizes.

### Base Collar



Part No.	Description	Weight
UBC	Base Collar	3.5 lbs
UBCB	Base Collar with Bushing	6.0 lbs

# SAFETY INSTRUCTIONS

## PRIOR TO ERECTION

1. Post these scaffolding safety guidelines in a conspicuous place and be sure that all persons who erect, dismantle, or use scaffolding are aware of them.
2. Always follow all state, local and federal codes, ordinances and regulations pertaining to scaffolding.
3. Prior to erecting scaffolding, survey the job site for hazards such as untamped earth fills, ditches, debris, high tension wires, unguarded openings and other hazardous conditions created by other trades. These conditions should be corrected or avoided.
4. Inspect all equipment before use. Keep all equipment in good repair. Do not use equipment that is damaged or deteriorated.
5. Scaffold design must include analysis of load-carrying members by properly qualified personnel. Load-carrying information is available from your UNIVERSAL DEALER or UNIVERSAL MANUFACTURING CORP.
6. Scaffold must be erected, moved or disassembled only under the supervision of competent persons.
7. Stationary scaffold over 125' in height and rolling scaffolds over 60' in height must be designed by a professional engineer.
8. Never take chances! If in doubt regarding the safety or use of the scaffold, consult your UNIVERSAL DEALER or UNIVERSAL MANUFACTURING CORP.
6. Install horizontal members on each rosette and firmly set wedges immediately before placing the next member. Do not stand, lean or put weight on horizontal members until the wedges are fully set.
7. Do not climb vertical posts, horizontal members or bracing. Use only proper safe access. Consult your UNIVERSAL DEALER or UNIVERSAL MANUFACTURING CORP. for access information.
8. Horizontal and/or vertical diagonal bracing may be required to prevent racking of the scaffold structure. Consult your UNIVERSAL DEALER or UNIVERSAL MANUFACTURING CORP.
9. Do not use truss bearers without thorough consideration for the loads to be supported. Do not cantilever truss bearers or other horizontal members.
10. Install guardrails, mid-rails and toeboards at all openings, open sides and ends of every working platform. Assure that guardrails, mid-rails and toeboards are in place whenever a scaffold level is planked. Guardrail posts must be secured to brackets or posts by pinning or bolting.
11. If prefabricated planks or platforms are used, use only planks designed to use on UNIVERSAL SYSTEM SCAFFOLDS.
12. Work platforms must be fully planked either with lumber that has been properly inspected and graded as scaffold plank or with fabricated platforms or planks in good condition.
  - a. Scaffold plank must have at least 12" of overlap and shall extend not less than 6" nor more than 12" beyond the centers of their end supports (bearers).
  - b. Single span planks must be cleated at both ends to prevent planks from sliding off their supports or must be of a prefabricated type having hooks to seat over bearers and restrain the planks from movement.
  - c. Secure planking to scaffold when necessary.
  - d. Planking must be placed across the full width of scaffold platforms.
13. Wall scaffolds must be butted and tied in to adequate anchors secured at least every 30' horizontally and at least every 26' vertically. To assure the stability of the scaffold during erection and dismantling, place the first level of ties and butts at a height above the base not greater than four times the width of the scaffold. Also, when extended more than one bay, install ties and butts at tops and ends of scaffold or lift above or beyond the previous tie position.
  - a. Ties should be installed as the erection progresses and not removed until the scaffold is dismantled to that height.
  - b. Cantilevered platforms, pulleys or hoist arms and wind conditions introduce overturning and uplift forces that must be considered and compensated. These assemblies may require additional bracing, tying or guying.
  - c. Circular scaffolds erected completely around or within a structure may be restrained from tipping by the use of a "stand off" bracing member.
  - d. Stair towers must be tied and butted at least every 13' vertically.
  - e. Each post of a free-standing tower must be guyed at the intervals outlined above or otherwise restrained to prevent tipping or overturning.
  - f. At every tie level, install continuous horizontal diagonal bracing for the full length of the scaffold.
14. After erecting scaffold, be sure screw jacks are in firm contact with starter collars or posts.
15. If in doubt as to the ability of the equipment to do a particular job, consult your UNIVERSAL DEALER or UNIVERSAL MANUFACTURING CORP.

## ERECTION OF FIXED SCAFFOLD

1. Scaffold base must be set on an adequate sill or pad. Base plates must be in firm contact with both sills and vertical posts. Any part of a building or structure used to support the scaffolding must be capable of supporting the load to be applied.
2. Use adjusting screws with base plates only to adjust for uneven grade conditions.
3. Wear safety glasses and hard hats when erecting and dismantling System Scaffolds.
4. Plumb and level all scaffolds at the base ring level as the erection proceeds. Do not force members to fit – level the scaffold until proper fit can be easily made.
5. Secure all wedge connections before assembly of next level.
1. Height of the tower must not exceed four times the minimum base dimension (three to one in the State of California). Outrigger frames or outrigger units on both sides of the tower may be used to increase base width dimensions when necessary.
2. All casters must be secured to adapters with nuts and bolts. Total weight of the tower should not exceed the capacity of the casters.
3. Screw jacks must not be extended more than 12" above the caster base. Tower must be kept level and plumb at all times.
4. Horizontal/diagonal bracing must be used at the bottom and top of tower and at intermediate levels of 20'. Fabricated plank with hooks may replace top diagonal brace.
5. Only prefabricated plank or cleated plank should be used.
6. Casters must be locked at all times the scaffold is not being moved.

## ERECTION OF ROLLING SCAFFOLDS

**U** UNIVERSAL  
MANUFACTURING

550 West New Castle St. • Zelienople, PA 16063 • [universalscaffold.com](http://universalscaffold.com)

800-836-8780 Fax: 724-452-0576